

KABELSCHUTZ SYSTEME

CABLE PROTECTION SYSTEMS

FLEXAhightemp
Feuerschutzschlauch
Fire Protection conduit

www.flexa.de



FLEXAhightemp Feuerschutz



🔥 -50°C ... +350°C ^ +700°C

FLEXAhightemp

Feuerschutzschlauch
Calciumsilikat-Geflecht mit
SI-Mantel

Fire protection conduit
Calcium-silicate-braiding with
SI sheathing



FLEXA No.	AD OD	NW			
rot red	ø		mm	kg/m	m
1 2061 809 010	17	10	10,0 x 17,0	0,119	15
1 2061 809 015	21	15	15,0 x 22,0	0,209	15
1 2061 809 020	27	20	20,0 x 27,0	0,213	15
1 2061 809 022	-	22	22,0 x 29,0	0,239	15
1 2061 809 025	-	25	25,0 x 32,0	0,291	15
1 2061 809 030	36	30	30,0 x 37,0	0,342	15
1 2061 809 035	-	35	35,0 x 42,0	0,390	15
1 2061 809 040	45	40	40,0 x 47,0	0,380	15
1 2061 809 050	56	50	50,0 x 57,0	0,733	15
1 2061 809 060	-	60	60,0 x 67,0	0,750	15

🔥 -50°C ... +350°C ^ +700°C

FLEXAhightemp Wickelband
Band mit fester Webkante

FLEXAhightemp Tape
Tape with tightly woven selvedges





FLEXA No.	Breite width	Stärke thickness		
rot red	ø		kg/m	m
1 2061 899 025	25	2 - 3	0,040	10
1 2061 899 050	50	2 - 3	0,080	10
1 2061 899 075	75	2 - 3	0,120	10
1 2061 899 100	100	2 - 3	0,170	10

🔥 -50°C ... +300°C

FLEXAhightemp Klebeband
für FLEXAhightemp
Feuerschutzschläuche

FLEXAhightemp Wrapping Tape
for FLEXAhightemp
fire protection conduits



FLEXA No.	Breite width		
rot red	ø	kg/m	m
1 2061 898 025	25	0,020	9

US

-40°C ... +125°C | +250°C [MSD]

Metall-Sicherheitsverschraubung
gerade, Außengewinde
inkl. Innentülle, Dichtring oder
Messing-Druckring [MSD] und O-Ring

Metal connector, safety-type
straight, outer thread
incl. ferrule, sealing or
brass thrust collar [MSD] and O-ring

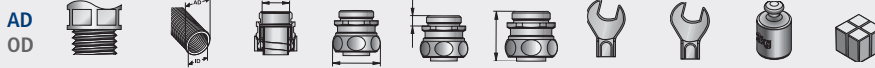

US-M

ø	Metr. EN 60423	mm	øI mm	øB mm	C mm	D mm	SW1 mm	SW2 mm	kg 100	St. pcs.
10	M 10 x 1,0	7 x 10	6,0	19,0	10,0	31,0	15	17	1,390	50
14	M 12 x 1,5	10 x 14	8,5	23,0	10,0	33,0	19	21	2,140	50
17	M 16 x 1,5	13 x 17	11,0	27,0	10,0	33,0	23	25	3,000	50
21	M 20 x 1,5	17 x 21	15,5	31,0	10,0	33,0	27	29	3,940	50
27	M 25 x 1,5	22 x 27	20,5	39,0	11,0	41,0	34	36	7,500	25
36	M 32 x 1,5	29 x 36	27,5	48,0	13,0	43,0	43	45	11,300	25
45	M 40 x 1,5	38 x 45	35,0	57,0	13,0	43,0	52	54	15,000	20
56	M 50 x 1,5	49 x 56	45,0	70,0	14,0	49,0	63	66	21,800	10
56	M 63 x 1,5	49 x 56	45,0	74,0	14,0	49,0	70	70	27,100	10

US-P

10	7	7 x 10	6,0	19,0	7,0	28,0	15	17	1,420	50
14	9	10 x 14	8,5	23,0	7,0	30,0	19	21	2,140	50
17	11	13 x 17	11,5	27,0	7,0	30,0	23	25	3,000	50
19	13,5	15 x 19	13,5	29,0	7,0	30,0	25	27	3,370	50
21	16	17 x 21	15,5	31,0	7,0	30,0	27	29	3,700	50
27	21	22 x 27	20,5	39,0	10,0	40,0	34	36	7,350	25
36	29	29 x 36	27,5	48,0	10,0	40,0	43	45	10,300	25
45	36	38 x 45	36,5	57,0	10,0	40,0	52	54	13,400	20
56	48	49 x 56	47,5	70,0	10,0	45,0	63	66	19,130	10

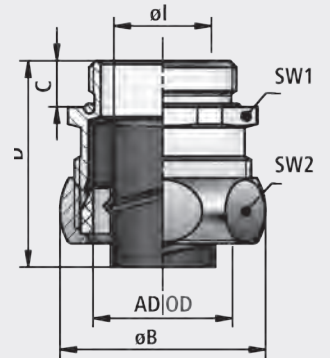

Metall-Schlaucholive
Sechskantschlüsselfläche
feststehendes Anschlussgewinde
inkl. O-Ring

Metal conduit olive
hexagon wrench surface
fixed outer thread
incl. O-Ring

-40°C ... +250°C

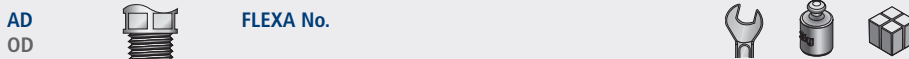

NIMS-M

ø	Metr. EN 60423	FLEXA No.	øI mm	øC mm	øD mm	E mm	F mm	SW mm	kg 100	St. pcs.
14	M 12 x 1,5	1 5010 023 012	7,0	9,0	15,5	6,4	29,0	14	0,360	10
17	M 16 x 1,5	1 5010 023 016	10,0	12,0	19,0	6,5	29,0	17	2,300	10
19	M 20 x 1,5	1 5010 023 020	12,0	14,0	24,3	6,5	29,0	22	3,400	10
21	M 25 x 1,5	1 5010 023 025	14,0	16,0	30,1	6,5	29,0	27	4,400	10
27	M 32 x 1,5	1 5010 023 032	19,0	21,0	39,1	6,5	32,1	35	8,600	5
36	M 40 x 1,5	1 5010 023 040	27,0	29,0	51,0	7,5	39,0	43	10,800	5
45	M 50 x 1,5	1 5010 023 050	35,0	37,1	59,5	10,0	47,0	54	16,000	5
56	M 63 x 1,5	1 5010 023 063	46,0	54,0	70,0	10,0	50,1	65	33,000	5

NIMS-P

ø	PG DIN 40430	FLEXA No.	øI mm	øC mm	øD mm	E mm	F mm	SW mm	kg 100	St. pcs.
14	9	1 5010 022 009	7,0	9,0	21,0	6,0	29,0	19	2,500	10
17	11	1 5010 022 011	10,0	12,0	24,0	6,0	29,0	22	3,200	10
19	13,5	1 5010 022 013	12,0	14,0	24,0	6,0	29,0	24	2,940	10
21	16	1 5010 022 016	14,0	16,0	26,0	6,0	29,0	24	3,500	10
27	21	1 5010 022 021	19,0	21,0	35,5	6,0	29,0	32	5,000	5
36	29	1 5010 022 029	27,0	29,0	44,0	8,0	39,0	41	10,000	5
45	36	1 5010 022 036	34,0	36,0	54,0	9,0	41,0	50	14,200	5

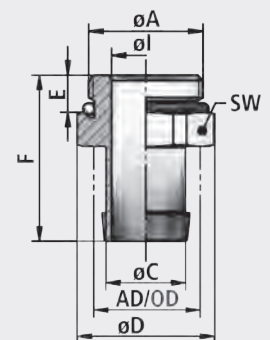

BERLIN LEIPZIG DRESDEN Sascha Gotta s.gotta@flexa.de www.flexa.de Tel 06181 677-153 Fax 06181 677-55153	FREIBURG R. Rantzuch KG info@rantzuch-et.de www.rantzuch-et.de Tel 07664 50569-0 Fax 07664 50569-0	HAMBURG Horst Falke Industrievertretungen e.K. info@horst-falke.de www.horst-falke.de Tel 040 67000-13 / -14 Fax 040 6703842	MÜNCHEN Handelsvertretung Süd Edgar Huemer huemer@hvsued.de www.hvsued.de Tel 0172 6666272 Fax 06181 677-55729	STUTTGART Handelsvertretung Süd Edgar Huemer huemer@hvsued.de www.hvsued.de Tel 0172 6666272 Fax 06181 677-55729
DORTMUND DÜSSELDORF Sönnecken GmbH soenneckengmbh@t-online.de Tel 0231 5600012 Fax 0231 590607	FRANKFURT MANNHEIM Alexander Trunk a.trunk@flexa.de www.flexa.de Tel 06181 677-156 Fax 06181 677-156	HANNOVER Sascha Gotta s.gotta@flexa.de www.flexa.de Tel 06181 677-153 Fax 06181 677-55153	NÜRNBERG Jacob Haag Nachfolger OHG info@haag-elektro.de www.haag-elektro.de Tel 09103 71370-0 Fax 09103 916 / 917	

UNSERE PARTNER IM AUSLAND

OUR AGENTS AND DISTRIBUTORS ABROAD

AUSTRALIA HARTING Australia Pty Ltd., Bundoora au@harting.com www.harting.com.au Tel +61 3 9466-7088	DENMARK Hans Følsgaard A/S, Koge hf@hf.net www.hf.net Tel +45 43208600	HUNGARY Q-TECH Ltd. & Co., Budapest info@q-tech.hu www.q-tech.hu Tel +36 1 405-3338	NORWAY Nortelco Treotham AS, Trollasen treotham@treotham.no www.treotham.no Tel +47 66778320	SPAIN Gaestopas S.L, Hernani gaestopas@gaestopas.com www.gaestopas.com Tel +34 943 376939
AUSTRIA Votohm GmbH, Sulz info@votohm.at www.votohm.at Tel +43 5522 494 20	FINLAND OEM Finland OY, Turku info@oem.fi www.oem.fi Tel +358 207 499499	INDIA TECHWORKS ENGINEERING Pvt. Ltd. BENGALURU murlidhar@tecwo.com www.jacob-gmbh.com Tel +91 80 67205555	POLAND Soyter Components Spolka z o.o. Sp. K, Izabelin handlowy@soyter.pl www.soyter.pl Tel +48 22 7528255	SWEDEN OEM Automatic AB, Tranas info@aut.oem.se www.oemautomatic.se Tel +46 75 2424100
BELGIUM S.A. Huppertz N.V., Wilrijk info@huppertz.be www.huppertz.be Tel +32 2 3343434	FINLAND Esbecon Oy, Nummela sales@esbecon.fi www.esbecon.fi Tel +358 9 22522-60	INDIA SR Indus Electro Sys Pvt Ltd. Bangalore Karnataka info@sindus.in www.sindus.com Tel +91 9632149525	POLAND OEM Automatic Sp. z o.o www.oemautomatic.pl info@pl.oem.se Tel +48 22 8632722	SWITZERLAND AGRO AG, Hunzenschwil info@agro.ch www.agro.ch Tel +41 62 8894747
BRAZIL Controall, Sao Paulo controall@controall.com.br www.controall.com.br Tel +55 11 2941-9490	FRANCE Baumann Sarl, Geispolsheim Gare www.baumann.fr info@baumann.fr Tel +33 3 88408500	ISRAEL Wave Mechanics Ltd., Kfar-Saba wave@wavetech.co.il www.wavetech.co.il Tel +972 9 7644-878	PORTUGAL Gaestopas Portugal, Alfena www.gaestopas.com portugal@gaestopas.com Tel +351 220 433 878	TAIWAN Faradick Co. Ltd., Taipei faradick@seed.net.tw www.faradick.com.tw Tel +886 2 27988187
BRAZIL Harting Ltda., Sao Paulo br@harting.com.br www.harting.com.br Tel +55 11 503500-73	FRANCE Groupe Intercables, Roquefort www.intercables.com info@intercables.com Tel +33 4 86186032	ISRAEL SystematITech Ltd., Tel Aviv sales@systematitech.com www.systematitech.com Tel +972 3 9605008	ROMANIA Pema electrotehnic srl, Drambar office@pema.ro www.pema-electrotehnic.ro Tel +40 258 806 924	THAILAND Compomax Co. Ltd., Bangkok info@compomax.co.th www.compomax.co.th Tel +66 2 1050555
BULGARIA Akhnaton Bulgaria AD, Sofia office@mail.akhnaton.netbg.com www.akhnaton.biz/en Tel +359 2 817600	FRANCE IMAGINELEC, Bain de Bretagne achats@imaginelec.com www.imaginelec.com Tel +33 2 99441524	ITALY Elektrozubehör S.p.A., Milano info@elektrozubehor.it www.elektrozubehor.it Tel +39 02 701471	SINGAPORE Hans Industries Pte. Ltd. sales@hansindustries.net www.hansengineering.com Tel +65 69557779	THE NETHERLANDS Hemmink B.V., Zwolle info@hanzestrohm.nl www.hemmink.nl Tel +31 85 4872400
CANADA IBIS Electro-Products Corp. Cambridge sales@ibisep.com www.ibisep.com Tel +1 800 350-7937 Tel +1 519 756-4299	FRANCE DIRECT SA, ZAC de la vente Olivier direct@direct.fr www.direct.fr Tel +33 2 32102343	ITALY DKC Europe S.r.L., Villanova Sull'Arda cosmec@dkceurope.eu www.dkceurope.de Tel +39 0321 9898910	SLOVAK REPUBLIC Distributor for Railways Draco s.r.o., Martin dracosro@gmail.com www.dracosro.sk Tel +421 43 4220577	TURKEY Harting Türkei Ltd., Istanbul info@harting.com www.harting.com Tel +90 216 6888100
CHINA AGRO (Shanghai) Electrical Products Trading Co. Ltd., Shanghai info@agro-electrical.cn www.agro-electrical.cn Tel +86 21 62825959	GREAT BRITAIN M. Buttkeireit Limited, Cheshire info@buttkeireit.co.uk www.buttkeireit.co.uk Tel +44 161 9695418	JAPAN Kinjo Denki Co. Ltd., Nagoya nagoya@neoflex.co.jp www.neoflex.co.jp Tel +81 52 5041-212	SLOVAK REPUBLIC ELETECHNIK s.r.o. www.eletechnik.sk Tel +421 33 2337480	TURKEY Ethos Enerji Iç ve Dis Tic. Ltd. Sti Maltepe Istanbul www.ethosenerji.com info@ethosenerji.com Tel +90 216 5270103
CZECH REPUBLIC Ex-Technik spol. s.r.o., Ostrava technik@ex-technik.cz www.ex-technik.cz Tel +420 596 242 548	GREAT BRITAIN OEM Automatic Ltd., Leicestershire information@oem.co.uk www.oem.co.uk Tel +44 116 2849900	MALAYSIA JJ-Lapp (M) Sdn. Bhd. Selangor Darul Ehsan sales_jjlm@jjsea.com www.jj-lapp.com Tel +603 50306322	SOUTH KOREA SLT Corporation, Gyeonggi-Do slt@sltco.co.kr www.sltco.co.kr Tel +82 31 776-4300	USA Aeros USA, Harrisburg, PA service@aerosusa.com www.aerosusa.com Tel +1 717 238 1444
CZECH REPUBLIC SVK Elektronik, s.r.o., Praha svk@svk.cz www.svk.cz Tel +420 2 81021305	HONG KONG Logistic Indus. Supply Co. Ltd. Hong Kong info@logistic.hk www.logistic.com.hk Tel +852 27439110	NEW ZEALAND Mardag Holdings Limited, Wellington info@mardag.co.nz www.mardag.co.nz Tel +64 4 237-8912	SOUTH KOREA WIT Solutions Co., Ltd. SONGPA-GU, SEOUL www.witsolutions.co.kr admin@witsolutions.co.kr Tel +82-2-2054-8691	USA Lapp USA, LLC., Florham Park, NJ sales@lappusa.com www.lappusa.com Tel +1 800 774-3539 Tel +1 973 660-9700

